

art. 194 Q-LINE

design: Studio Reguitti
 materiale: Impugnatura Zama
 material: Lever Zamak

TeKnoMetal
 Linea in zama

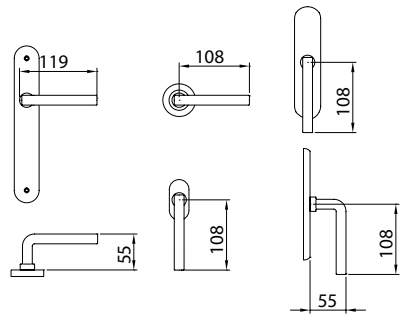

194 MR 416 ZSC



194 MR Q08 SNV



194 MR Q08 ZCR



194 MR Q09 ZSC



194 MP 130 ZSC



194 DK 015 ZSC
 194 DK 024 ZSC



194 DK Q15 ZSC

VERSIONI / VERSIONS



Finiture
Finishes

ZSC
ZCR



SNV

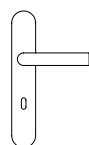

MANIGLIA CON PLACCA / LEVER HANDLE ON PLATE

	194 MP 188	Maniglia con placca Lever Handle on plate	188 mm 255x42	con molla e grano with spring and grub screw	•	•	1
	194 MP 130	Maniglia con placca Lever Handle on plate	130 mm 245x50	con molla e grano with spring and grub screw	•	•	1

MANIGLIA CON ROSETTA / LEVER HANDLE ON ROSE

	194 MR 005	Maniglia con rosetta Lever Handle on rose	005 mm Ø50x8	tipo lusso con molla e grano lusso type with spring and grub screw	•	•	1
	194 MR 416	Maniglia con rosetta Lever Handle on rose	416 mm Ø45x9	con molla e grano with spring and grub screw	•	•	1
	194 MR 816	Maniglia con rosetta Lever Handle on rose	816 mm Ø50x10	con molla e grano with spring and grub screw	•	•	1
	194 MR Q09	Maniglia con rosetta Lever Handle on rose	Q09 mm 61x31	con molla e grano with spring and grub screw	•	•	1
	194 MR Q05-71	Maniglia con rosetta Lever Handle on rose	Q05 mm 50x50	lusso con molla e grano con bocchetta Q08 lusso type w/spring, grub screw, rose for key Q08	•	•	1
	194 MR Q05-72	Maniglia con rosetta Lever Handle on rose	Q05 mm 50x50	lusso con molla e grano con bocchetta Q08 yale lusso type w/spring, grub screw, rose for key Q08 yale	•	•	1
	194 MR Q08	Maniglia con rosetta Lever Handle on rose	Q08 mm 50x50	con molla e grano with spring and grub screw	•	•	1

CREMONESE / WINDOW HANDLE WITH MECHANISM

	194 SG 070*	Cremonese con placca Window Handle on plate	070 mm 189x36	coprivite con gioco with cover-screw plate with mechanism	•	•	2
	194 SG Q13*	Cremonese con placca Window Handle on plate	Q13 mm 160x33	coprivite con gioco with cover-screw plate with mechanism	•	•	2

MARTELLINA / WINDOW HANDLE WITHOUT MECHANISM

	194 SE 070*	Martellina con placca Window Handle on plate	070 mm 189x36	coprivite q.7 with cover-screw plate with square-pin mm 7	•	•	2
	194 SE Q13*	Martellina con placca Window Handle on plate	Q13 mm 160x33	coprivite q.7 with cover-screw plate with square-pin mm 7	•	•	2

DREH KIPP / DREH KIPP

	194 DK 024	Dreh Kipp con rosetta Dreh Kipp on rose	024 mm 65x31	con mov. in metallo e quadro autoregolante with metal mec. and adjustable square-pin	•	•	3
	194 DK Q15	Dreh Kipp con rosetta Dreh Kipp on rose	Q15 mm 65x31	con movimento in metallo with metal mechanism	•	•	3

* Placca adatta a movimenti intercambiabili
Plate suitable to interchangeable movements



194 MR Q05-71 ZSC
Sottorosetta in metallo



194 MP 188 ZSC

Per caratteristiche tecniche rosette vedi apposito capitolo soluzioni tecniche e componenti / For technical specifications rosettes see specific section technical solutions and components

A RICHIESTA / ON REQUEST:

- Mezza maniglia con placca o con rosetta (specificare se destra o sinistra) / Half lever handle on plate or on rose (to specify if right or left)
- Maniglia con rosette senza bocchette / Lever handle on rose without rose for key
- Coppie impugnature (CM) con grano e ferro senza rosette e senza bocchette / Pair levers (CM) with grub screws and square pin without rose and without rose for key