

# art. 121 APRI

design: Studio Reguitti  
 materiale: Ottone  
 material: Solid Brass

**Brass Class**  
 100% Ottone

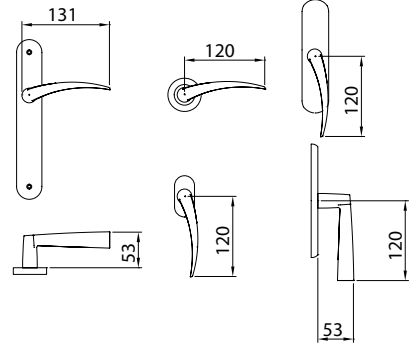

121 MR Q86 OSC



121 MR 816 OC



121 MR 416 OSC



121 MR 005 LV



121 MR 916 OS



121 MP 188 OSC

destra/right



121 DK 015 LV

destra/right



121 DK Q15 OC

## VERSIONI / VERSIONS



Finishes

LV  
OS





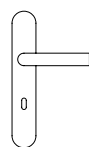

OSC  
OC



### MANIGLIA CON PLACCA / LEVER HANDLE ON PLATE

	121 MP 188	Maniglia con placca Lever Handle on plate	188 mm	255x42	con molla e grano with spring and grub screw	•	•	1
	121 MP 130	Maniglia con placca Lever Handle on plate	130 mm	245x50	con molla e grano with spring and grub screw	•	•	1

### MANIGLIA CON ROSETTA / LEVER HANDLE ON ROSE

	121 MR 005	Maniglia con rosetta Lever Handle on rose	005 mm	Ø50x8	tipo lusso con molla e grano luxu type with spring and grub screw	•	•	1
	121 MR 416	Maniglia con rosetta Lever Handle on rose	416 mm	Ø45x9	con molla e grano with spring and grub screw	•	•	1
	121 MR 816	Maniglia con rosetta Lever Handle on rose	816 mm	Ø50x10	con molla e grano with spring and grub screw	•	•	1
	121 MR 916	Maniglia con rosetta Lever Handle on rose	916 mm	62x32	ovale con molla e grano oval with spring and grub screw	•	•	1
	121 MR 9Q6	Maniglia con rosetta Lever Handle on rose	9Q6 mm	61x31	con molla e grano with spring and grub screw	•	•	1
	121 MR Q86	Maniglia con rosetta Lever Handle on rose	Q86 mm	50x50	con molla e grano with spring and grub screw	•	•	1

### CREMONESE / WINDOW HANDLE WITH MECHANISM

	121 SG 070*	Cremonese con placca Window Handle on plate	070 mm	189x36	coprivite con gioco with cover-screw plate with mechanism	•	•	2
	121 SG Q13*	Cremonese con placca Window Handle on plate	Q13 mm	160x33	coprivite con gioco with cover-screw plate with mechanism	•	•	2

### MARTELLINA / WINDOW HANDLE WITHOUT MECHANISM

	121 SE 070*	Martellina con placca Window Handle on plate	070 mm	189x36	coprivite q.7 with cover-screw plate with square-pin mm 7	•	•	2
	121 SE Q13*	Martellina con placca Window Handle on plate	Q13 mm	160x33	coprivite q.7 with cover-screw plate with square-pin mm 7	•	•	2

### DREH KIPP / DREH KIPP

	121 DK 015	Dreh Kipp destro con rosetta Dreh Kipp (right) on rose	015 mm	65x31	con movimento in metallo with metal mechanism	•	•	3
	121 DK Q15	Dreh Kipp destro con rosetta Dreh Kipp (right) on rose	Q15 mm	65x31	con movimento in metallo with metal mechanism	•	•	3

\* Placca adatta a movimenti intercambiabili  
Plate suitable to interchangeable movements



121 MP 130 OSC



121 MR Q86 OC



121 MR 9Q6 OSC

Per caratteristiche tecniche rosette vedi apposito capitolo soluzioni tecniche e componenti / For technical specifications rosettes see specific section technical solutions and components

#### A RICHIESTA / ON REQUEST:

- Mezza maniglia con placca o con rosetta (specificare se destra o sinistra) / Half lever handle on plate or on rose (to specify if right or left)
- Maniglia con rosette senza bocchette / Lever handle on rose without rose for key
- Coppie impugnature (CM) con grano e ferro senza rosette e senza bocchette / Pair levers (CM) with grub screws and square pin without rose and without rose for key